



MAGNETIC POWER SYSTEMS, INC.

1626 MANUFACTURERS DRIVE

FENTON, MO 63026, USA

PHONE: 636.343.5550

FAX: 636.326.0608

## A DANCER PRIMER

Copyright 1999 Magnetic Power Systems, Inc.

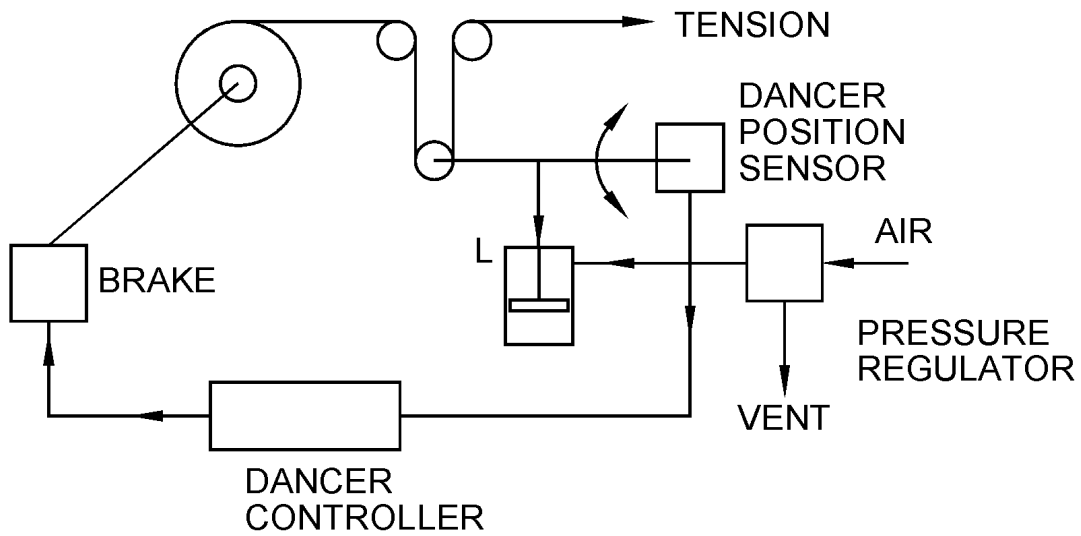

There are various methods of automatically controlling tension in a web of material being processed. These methods fall into two general categories, open loop and closed loop. The open loop systems can usually be reduced to some method of roll radius determination, and the programming of torque proportional to radius. These include follower arms, roll radius computers, ultrasonic roll measuring and manual operation. The other category is closed loop feedback system. Each type of system has its own advantages, and is selected by the designer on the basis of price, performance, and ease of design, installation and set-up.

On unwinds, dancer arm tension control systems are used primarily because of their forgiving nature to tension changes. These changes or transients are caused by velocity errors due to out of round rolls, pitch line variations, out of balance rolls, machine acceleration or deceleration, and intermittent type cutting, printing or processing variations. Since the material being processed will stretch, these velocity errors are converted to tension changes. The dancer being free to move, tends to absorb these changes.

The purpose of the dancer arm is the automatic control of the braking torque on the unwind roll to maintain constant web tension. This eliminates operator dependency, and provides more accurate control of tension.

### DANCER SYSTEM

Let's look at a typical dancer control system.

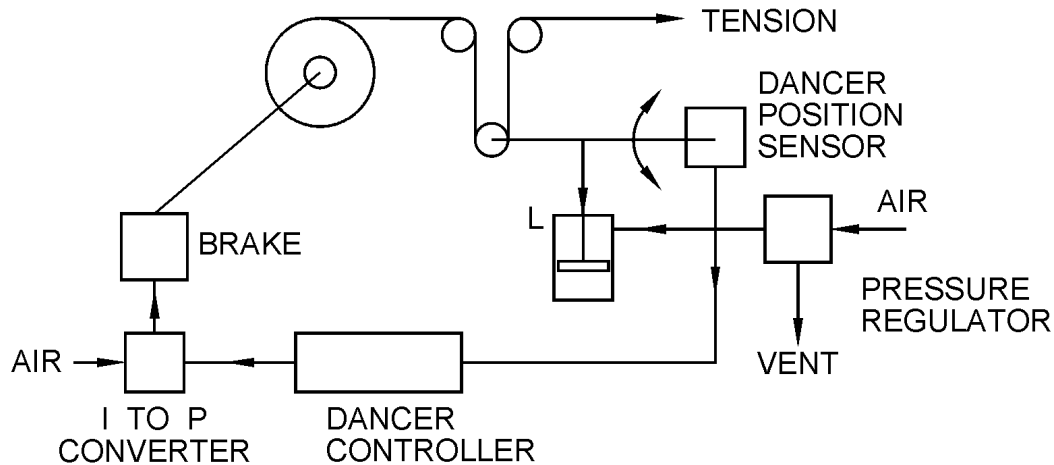

Figure 1

In this system, the restraining torque is provided by a pneumatic brake, which is operated by a current-to-pressure proportional valve, being controlled by the dancer tension controller. A magnetic particle brake could also be used, in which case, the I to P valve is not needed. The position of the dancer arm is monitored by a dancer position sensor, and the load on the arm is provided by an air cylinder and pressure regulator.

In its most simplistic format the dancer roll and its load are suspended by the web tension, and if the tension increases, the roll rises. This signals the system to reduce torque, and thereby tension, so the roll can return to its original position. While this is a basic description, we need to look closer at the dancer roll and the forces acting upon it, in order to determine the effects of all the parameters on the dancer design.

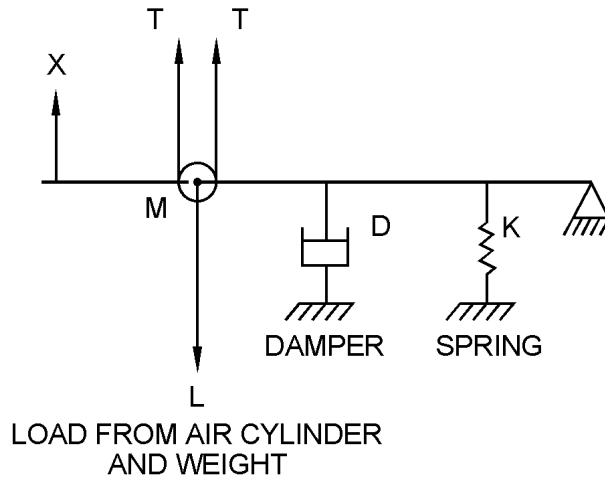

Figure 2

For figure 2 we can write the “first commandment” of dancers.

THE LOAD ON THE DANCER SETS THE TENSION IN THE WEB.

For this we can write the equation for the loads,

$$2T = L + M \frac{d^2x}{dt^2} + D \frac{dx}{dt} + Kx$$

The terms of this equation are as follows:

T = Web tension

L = load set by the air cylinder plus the weight

M = Mass of the dancer

$\frac{d^2x}{dt^2}$  = A = acceleration    F = MA

D = Dashpot or damping factor (shock absorber)

$\frac{dx}{dt}$  = V = velocity of the damper

K = Spring rate

X = deflection from set point

What we really want to achieve in a dancer is:

$$T = L/2$$

i.e. if the load on the dancer is fixed, the tension is constant. But we have a lot of terms on the right side of the equation which we wish were zero. Let’s look at each one while we keep the “second commandment” of dancers in mind.

## THE LOAD ON THE DANCER MUST BE CONSTANT.

Looking at MA (mass times acceleration), we cannot do anything about the A portion of this term, as we have seen that the cause of all the problems were the velocity changes, and a velocity change is acceleration by definition. Therefore, we can only control the mass M. We should keep the mass as small as possible. A perfect dancer has no mass. Therefore, make the dancer assembly as light as possible. This leads to a corollary, do not counterbalance a dancer with weights! Do not load a dancer with weights!

Looking at the velocity (or dashpot) term, we can see that we cannot control the v, i.e. the dancer must move to absorb velocity changes, so we must not put any shock absorbers or dashpots, or dampeners on the dancer arm. With no D, this term goes to zero (you should also eliminate friction and "striction" in the dancer pivot). A shock absorber may stop the "bouncing" of a poorly designed dancer system, but the tension transients are still there – you just can't see them. Carrying this to the extreme would be bolting the dancer solid, then we wouldn't see anything.

Looking at the spring term, Kx, we can see that if we put a spring on a dancer, as it deflects the force increases or decreases in proportion to the movement. This is in direct violation of commandment #2, which says the load on the dancer should be constant.

If we don't use springs, and don't use shock absorbers, and keep the mass of the dancer very low, we can then rewrite the equation as:

$$T = L/2$$

Now the tension is set by the load on the dancer. Now let's review what it takes to abide by commandment #2, "The Load On the Dancer Must Be Constant".

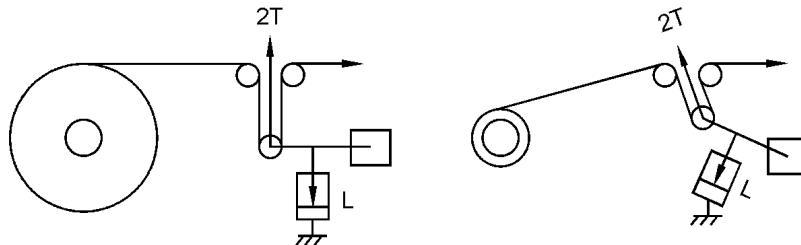

Figure 3

The loading device should be independent of position, velocity, or direction of motion. Looking at figure 3, we can see the effects of position.

The dancer arm should be long enough, and the dancer should be positioned far enough away from the adjacent idler rolls, so the mechanical advantage does not significantly change the load on the dancer arm, as shown in figure 3. Total throw arcs of 30 to 90 degrees are most common. Also, as the air cylinder changes position, it should not have any internal friction, or tendency to "stick" then slip. An air cylinder with a long stroke, rolling diaphragm, linear bearings, and no shaft seals is the type which should be used on dancers.

## AIR CYLINDER LOADING AND CAUTIONS

Velocity will affect the air cylinder and regulator combination as the cylinder is forced to a new position by dancer movement, or as it extends to follow a slackening in the web. Here is where the air pressure regulator can make or break a dancer system.

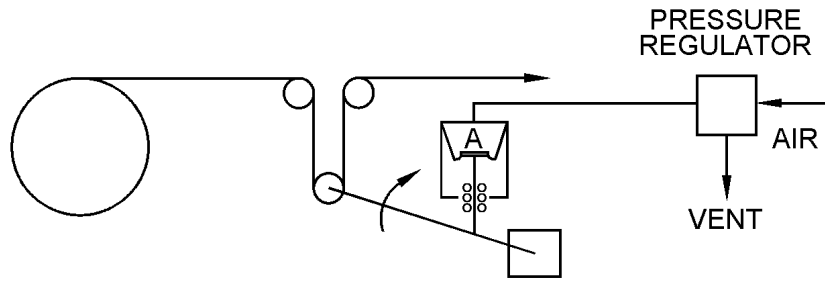

Figure 4

Here in figure 4, a transient is pulling the dancer upwards. The pressure increase in cylinder "A", and the regulator, sensing this pressure change, dumps air from cylinder "A" through the vent to the atmosphere, keeping the pressure in change "A" constant, therefore, the load on the dancer is constant, therefore tension is constant. This is the ideal case.

To approach this ideal case, the regulator must be a "sensitive relieving regulator". If the regulator relieving pressure is a significant increase over the set point, corresponding tension changes will result. This is one of the most frequent design errors in dancer systems.

The "flow rate" of the regulator is also important. If the regulator is small and the volume of air to be relieved is large, the pressure will rise in the cylinder because the air passages are too small. This is also true when the cylinder must expand to stay in contact with a slackening web. You must be able to introduce air into the chamber fast enough.

Note, all the above are also necessary for an air cylinder used to "balance" the dancer arm weight, so sometimes vertical dancers can be used to eliminate the counter balancing weights or air cylinder and regulators.

One "trick" used by some designers, is the addition of an air reservoir between the regulator and the air cylinder. The size of the reservoir is determined by the relative sizes of the cylinder and regulator, but it should be quite larger than the volume of the cylinder. If, for example, it were 25 times the cylinder volume, the pressure would only change 4% through a full stroke of the cylinder, even if the regulator did not relieve the pressure. A large reservoir will, however, take longer to pressurize at a set point change, but this should have no effect on systems operations.

#### LONG STROKE DANCER / ACCUMULATORS

If very long stroke dancers or multiple pass accumulators are being designed, it is difficult to get air cylinders with the stroke required with low frictional drag. In this case, a magnetic particle clutch which is driven by a gear motor, and has a drum and cable arrangement has been used successfully. See figure 5.

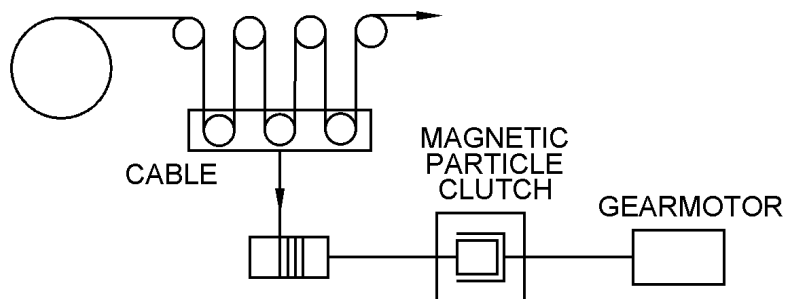

Figure 5

This technique allows long stroke while the clutch provides force independent of velocity or direction, has low inertia, and is easily and precisely regulated to set the web tension.

Now assuming the dancer arm and loading system has been properly designed to meet the first two commandments of dancers.

THE LOAD ON THE DANCER SETS THE TENSION IN THE WEB.

THE LOAD ON THE DANCER MUST BE CONSTANT.

We can then start to review the requirements of the control system, i.e. sensor, controller, brake.

### THE CONTROL SYSTEM

A dancer system as shown in figure 1 is a “closed loop” or “feed back” system. In a “closed loop” system, the measured value (tension or dancer position) is “fed back” to a comparator, which takes the difference between actual and the set point values, and sends this difference (or error signal) to the controlling element. The controlling element (or brake) torque is adjusted to return the tension or dancer position to its set point. Control theory tells us that every closed loop system will oscillate at its natural frequency. The natural frequency of a web system is dominated by the inertia of the unwind roll and the spring rate (modulus of elasticity) of the web. It is the control system’s job to regulate the tension and position while not allowing the system to oscillate. This is done by having the correct Proportional, Integrator, and Derivative (PID) parameters set in the control. The integrator sets how fast the torque changes to correct for errors in tension or position. It sets the basic responsiveness of the system. For the most accurate tension control, we want the most responsive system that does not oscillate. In the Versatec, the proper operating parameters are automatically set during a simple tuning procedure.

### TUNING

Hold the dancer arm in its desired positions, and hold down the + and – keys until the display reads “ok”: This sets the dancer position. In a basic clutch or brake controlled system, with no diameter feedback, the system is then run at a slow speed with a small roll (near the core). Press the – key until the system starts to oscillate, then the + key until oscillations stop. This sets the system near core. This procedure is then repeated at a full roll, and the tuning is complete. The control stores the values needed to run a stable system.

In older analog type controls, the output of the control was proportional to the dancer position, i.e. the dancer was “low” at full roll, and “high” at core.

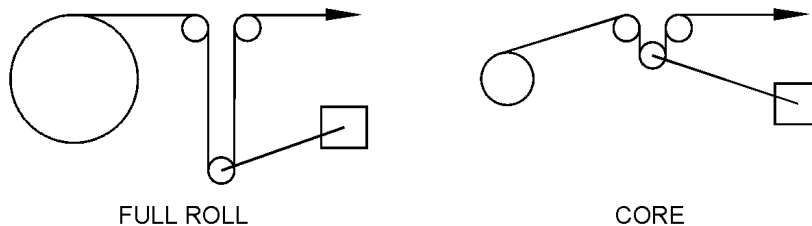

Figure 6

This meant that available dancer travel was always limited at both full roll and core. In the new Versatec™ microprocessor systems, the digital integrator constantly drives the dancer to the set point which was stored in memory. This insures full dancer travel available at all times. In many cases, this means less dancer travel is needed, however, having more travel available is generally better than having less travel available.

The Versatec can also measure the diameter of the roll with an ultrasonic sensor. When this feature is used, the control can then compensate for very large diameter ratios and large inertia changes which may be uncontrollable by less sophisticated systems.

## DANCER POSITION SENSORS

The MAGPOWR DFP sensor has a rugged 5/8 diameter shaft, mounted on two sealed ball bearings, and the potentiometer also has two precision instrument grade ball bearings. The pot is coupled to the shaft by a special flexible coupling. The housing is heavy duty (up to 1/2" thick) aluminum, with a neoprene and cork gasket. The DFP2 is a more compact version, with the same quality potentiometer, however, the potentiometer has a 1/4" diameter shaft.

## UNWIND BRAKES

The magnetic particle brake is generally selected for the precision jobs, as its torque control is linear, repeatable, smooth and independent of speed. They work equally as well at high rpm, or at very low rpm. MAGPOWR has these units available in ratings from 2 in-lbs to 100 ft-lbs.

The pneumatic friction brake used on unwinds is typically a puck and disk type. The full face disk type, or the full contact band type are generally much more erratic in torque control, due to the inability to maintain full face contact under all conditions of torque and speed. MAGPOWR's DDB Double Disk Brake is specifically designed for tension unwind applications. It has a wide torque range (over 1600 to 1 in the larger sizes) with each of 3 pad coefficients. The double disk design allows up to 25 hp to be dissipated to air, eliminating the need for water cooling. The quick change friction pads, individual pad control and smooth operation, even at slower speed, makes it the best choice for large wide range, high dissipation applications.

## CONCLUSIONS

When designing dancer systems, remember these commandments:

THE LOAD ON THE DANCER SETS THE TENSION IN THE WEB.

THE LOAD ON THE DANCER MUST BE CONSTANT

Select the dancer arm loading elements with these rules in mind and you will have a system capable of being controlled. Select the feedback sensors, controller and brake with the features needed to achieve successful control. Then all you have to do is tune it and run it.

When can you break one of the commandments? You can't, on unwinds which have to cover a wide range. On rewinds, sometimes a dancer control is used but taper winding tension is desired. In this case, we can adjust the load on the dancer to create a taper. This auxiliary output to control a dancer air cylinder and the taper tension adjustment are standard features in the Versatec.